

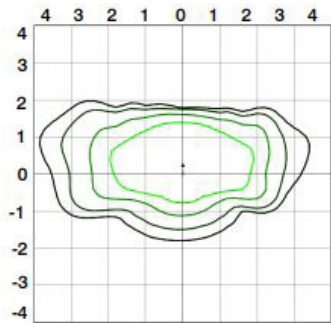

Energy Harness® LED Cut-Off Wall Packs have a versatile full cut-off or semi-cut off design. The same model will meet both full cut-off and semi-cut off designs simply by installing the back-plate upside down. Multiple installation methods allow this fixture to be used as a flood light as well. With wattages ranging from 35 -120W, this wall pack will cover all your lighting needs.



Full Cut-Off

Photometrics

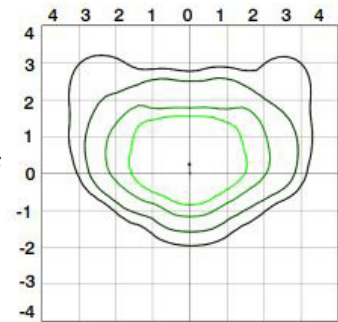

Semi Cut-Off

Features

- 2 – in – 1 Fixture: Full cut-off and Semi cut-off options from same model
- Versatile Mounting: Junction box (standard) | surface | or slip fitter mounting
- Finish: Dark Bronze (standard) | Black | Grey | White

Applications

- | | |
|--|--|
| <ul style="list-style-type: none"> - Loading Docks - Schools - Outdoor Pathways | <ul style="list-style-type: none"> - Residential Areas - Parking Lots - High Security Areas |
|--|--|



Specifications

- IP65
- Dimmable 0-10V
- Power Factor > 0.9
- Lifespan > 50,000hrs
- Operating Ambient Temp: -40°F - 104°F
- CRI >70
- Optics: Type 2 | Type 4

Accessories



Emergency LED Driver
(90 minutes) BBU



Motion Sensor | PIR | 0-10V Dimming
Switch or Remote Control | MS



Button Photocell | BPC



Junction box plate (included)



Surge Protection Device
(Field installed) | EHA- SURGE



Slip Fitter Mount for Installation |
SFA

Cut-Off Features

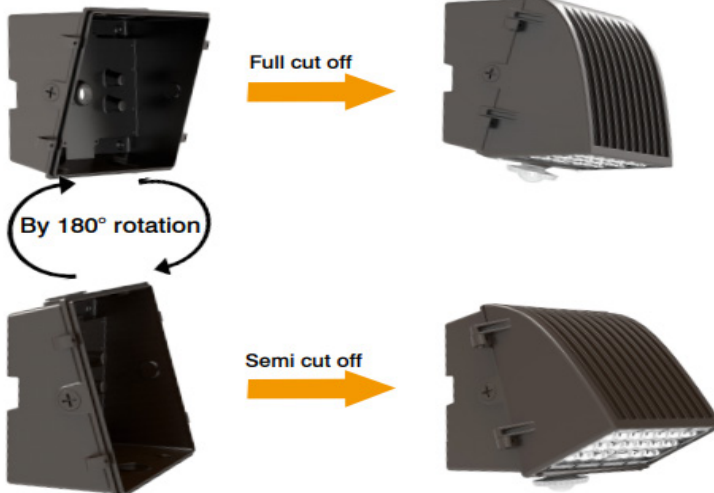

Dimensions

35W Models

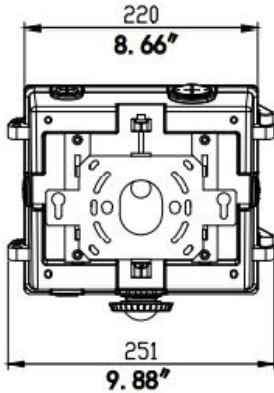

Back

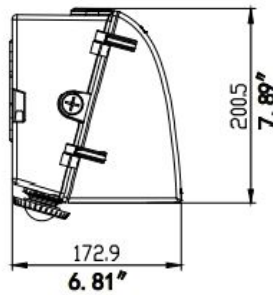

Full Cut-Off

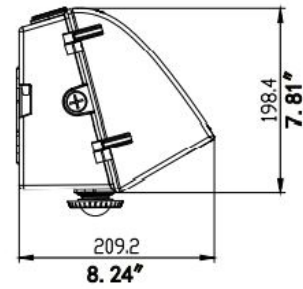

Semi Cut-Off

75-120W Models

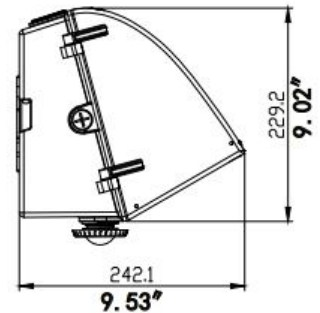
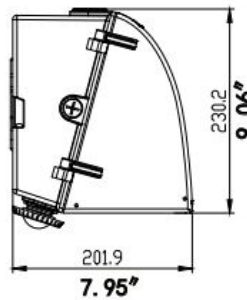
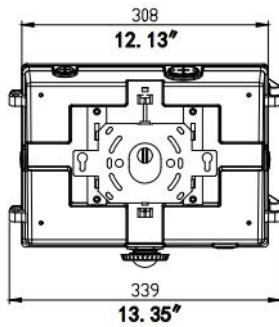

Lumen Packages

EHF-WPC-4-35		EHF-WPC-4-75		EHF-WPC-4-120	
Wattage	Lumens	Wattage	Lumens	Wattage	Lumens
35	3030	75	3030	120	3030

Ordering Guide

Example Model Number: EHF-WPC-4-7550K-277-D010-BK-MS

Product Series	EHF-WPC
Light Distribution	1 = Type 2 2 = Type 4 (Standard)
Wattage	35 = 35W 75 = 75W 120 = 120W
CCT	30K = 3000K 50K = 5000K (Standard) 40K = 4000K
Input Voltage	277V = 120-277V (Standard) 480V = 277-480V
Dimming	Left Blank = Non dimmable D010 = 0-10V dimmable (Standard)
Fixture Color	BK = Black Powder Coat BR = Bronze (Standard) GY = Grey Powder Coat WH = White
Accessories	MS = Motion Sensor BBU = Battery Backup Unit
Model Number:	EHF- WPC ____ - ____ ____ k - ____ - ____ - ____ - ____
Project Name:	
Date:	
Specified By:	